

# Safe Bathing for Commercial Remodeling

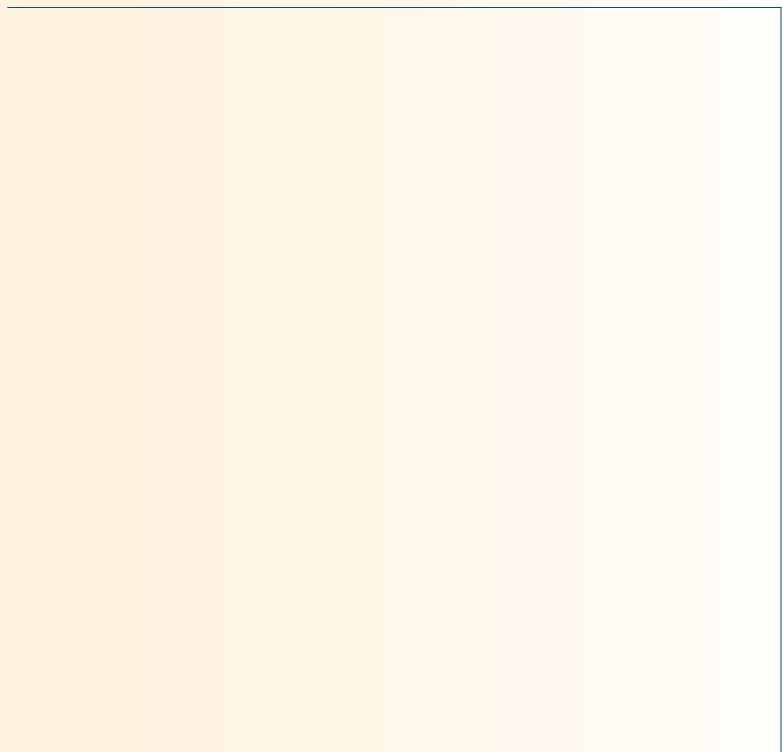

The Most Powerful Warranty in the Industry

# the last shower remodel you will ever need!

30 year durability, strength and value are built into each leak-proof retrofit shower!  
Multi-Piece easy installation - Custom Tile Accent Color

Locking Water Tight Corners



Leak Proof Wall to Wall Seams



Leak Proof Wall to Base Seams



Composite Wall Structure

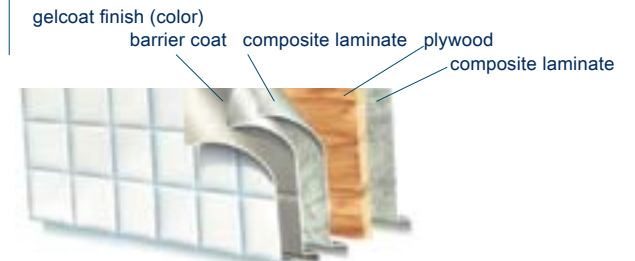

Composite Floor Structure

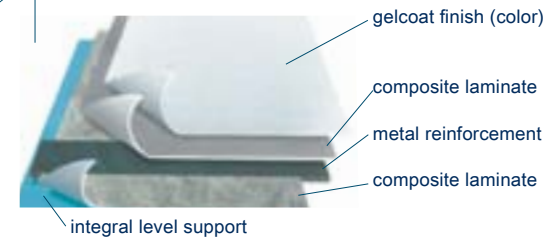

LIMITED  
*30 Year Warranty*  
All Showers - Tub Showers - Pans  
Best Bath  
Made in America

Offering a full line of multi-piece showers to fit any size requirement. Fast, professional installation lessens expense and adds value. You can have great looks and solid performance.

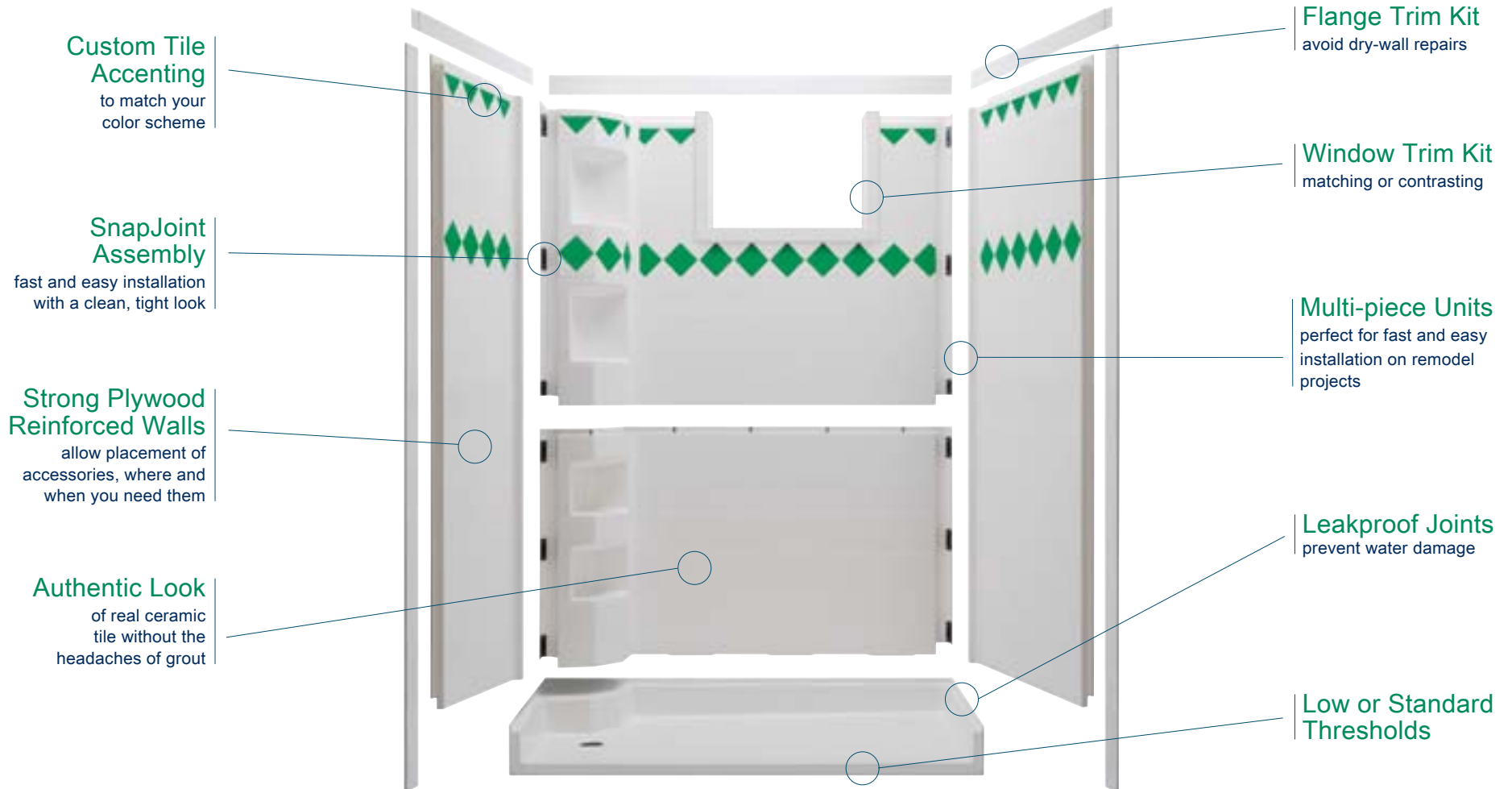

Easy to install, easy to maintain and easy to repair.



Made in America

# unifloor

## Commercial Grade, One-Piece European Style Room System

UniFloor is a high quality one-piece flooring solution from Best Bath. Check out the many advantages of UniFloor:

- No seams. The one-piece design eliminates all bathroom floor cracks, joints, seams and pores.
- Less space. An integrated shower area combines the turning radius for both toilet and shower.
- Improved bathroom maintenance. The durable, tough surface is easy to clean and maintain a sanitary environment.
- A sloped floor for consistent drain means no mud set required.
- An integral beveled toilet base allows for easy placement and install.
- Constructed to last thirty years.
- Eliminates expensive and cumbersome floor liners.
- Bathroom installation and construction time is dramatically reduced.

We offer custom bathing solutions for unique project requirements. Best Bath has turn-key design capabilities from concept engineering and prototype through final installation.



LIMITED  
*30 Year Warranty*  
All Showers - Tub Showers - Pans  
Best Bath  
Made in America

# one-piece and multi-piece ada systems

## 3838 ADA Package

LCS3838A5T



Package includes:

Factory installed:

- 18" x 33" x 1.25" stainless steel corner grab bar
- 34"X21" padded seat w/swing down legs
- Symmons ADA compliant mixing valve and hand spray system
- Surface mount soap dish, and curtain rod brackets.
- No caulk drain

## 6333 ADA Package

LCS6333A75B  
CA TITLE 24118  
LCS26333A75BCG



Package includes:

Factory installed:

- 27" x 36" x 1.25" stainless steel corner grab bar
- 28"X21" padded seat w/swing down legs
- Symmons ADA compliant mixing valve and hand spray system
- Surface mount soap dish, and curtain rod brackets.
- No caulk drain

## 6337 ADA Package

LCS6337A75B  
CA TITLE 24118  
LCS26337A75BCG



Package includes:

Factory installed:

- 32" x 36" x 1.25" stainless steel corner grab bar
- 34"X21" padded seat w/swing down legs
- Symmons ADA compliant mixing valve and hand spray system
- Surface mount soap dish, and curtain rod brackets.
- No caulk drain

## 6032 ADA Package

Tub/Shower combo



Package includes:

Factory installed:

- 1-12" x 1.25" Stainless Steel Grab bar
- 1-24" x 1.25" Stainless Steel Grab bar
- 1- 27" x 36" x 1.25" Stainless Steel Corner Grab Bar
- 1-SEAT, 30X15 Padded Naugahyde
- Symmons ADA compliant mixing valve and hand spray system and diverter spout
- Surface mount soap dish, and curtain rod brackets.

• Quick Ship • Complete Shower System • No Recess ADA Factory Installed Accessories • Time Saving

Constructed of durable, luxurious gelcoat fiberglass • Full plywood backing on all walls for outstanding strength • Easy, snap-in-place installation from the front.

# lifetime shower system

## The Last Shower Remodel You Will Ever Need

Remodeling with a Lifetime Shower allows you to easily adapt your shower as bathing needs change.

Durability, strength and value are built into every adaptable shower we offer! Leak proof, easy installation multi-piece showers – Custom accent color available.

Standard curbed shower with glass door



Safe, accessible shower in place without extensive remodeling



The Lifetime Shower is an adaptable shower. It has a semi-permanent threshold strong enough to hold a shower door or be removed for safe, low threshold accessibility.

After removing the door & semi-permanent threshold, the minimum height shower curb with installed WaterStopper is revealed.

Adaptable? You Bet! As your needs change the process is reversible. The threshold is put back in place and the shower door reinstalled. It easily converts back to a standard shower.

LIMITED  
*30 Year Warranty*  
All Showers - Tub Showers - Pans  
West Bath  
Made in America

This shower can easily convert to a safe low-threshold shower by:



Removing the shower door



Cutting the silicone around the semi-permanent threshold



Lifting off the threshold

The Lifetime  
Shower System

The Lifetime Shower System is definitely the way to go. We offer Lifetime Showers to fit any size requirement.

# hospitals, senior living and university remodel

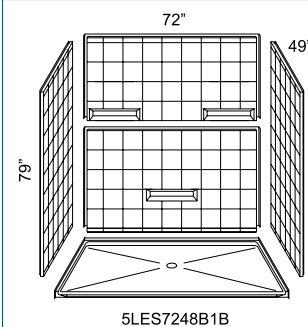
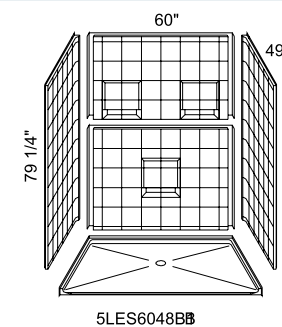
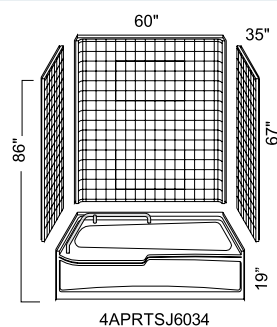
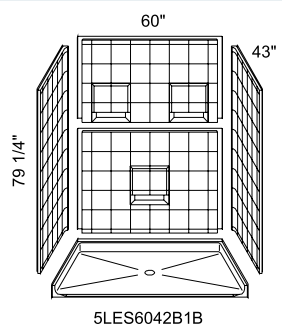
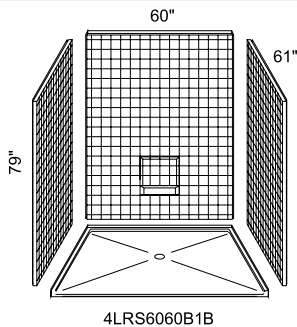
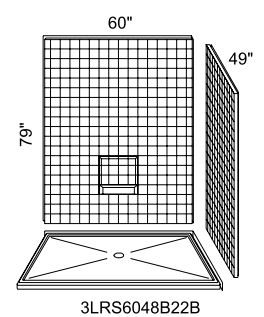
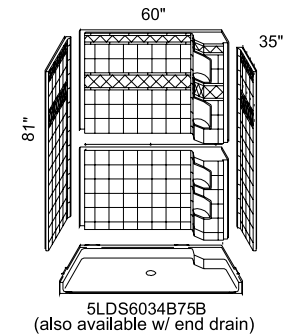
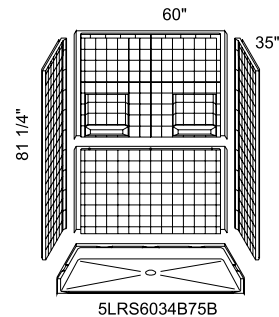
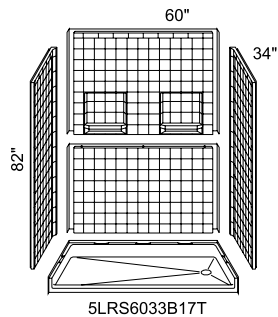
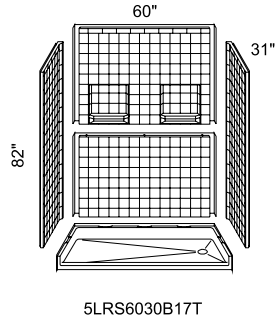
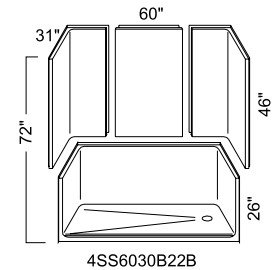
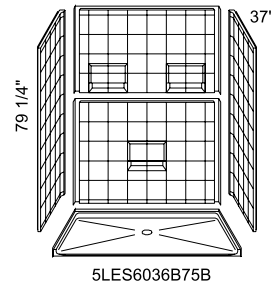
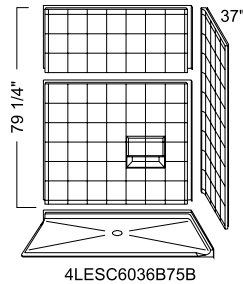
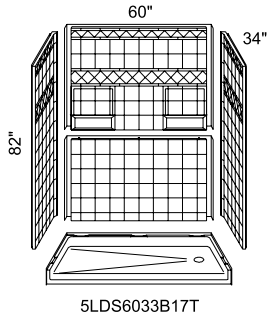
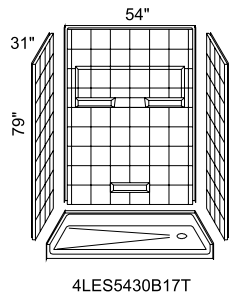
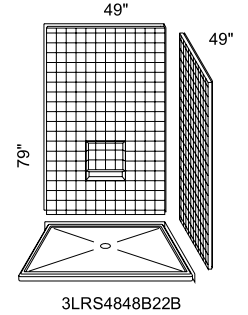
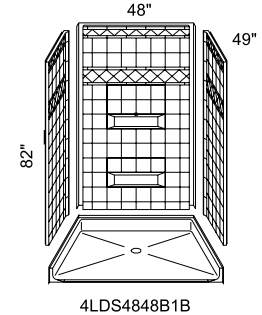
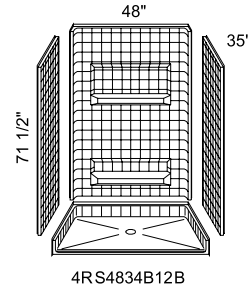
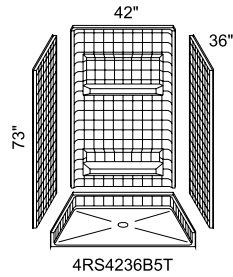
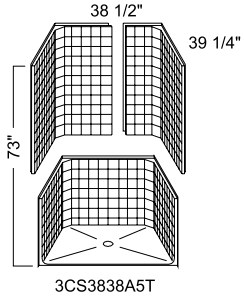

Pans only are offered for all units. Many more models are available than what is shown.

# walk-in models



escape

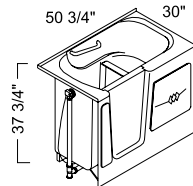

LTOW5030

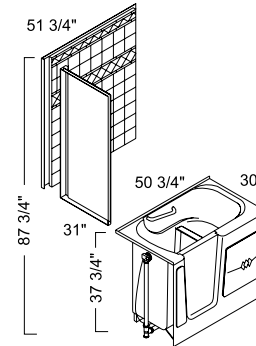

LTOW5030 - With two walls

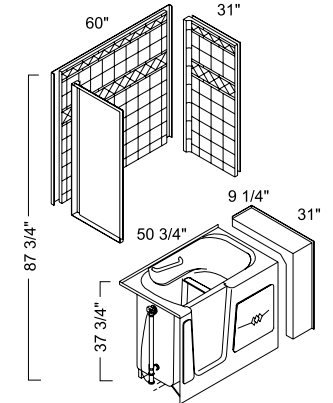

LTOW5030 - With three walls and extension



liberty

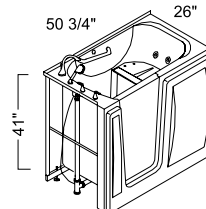

XTW5026

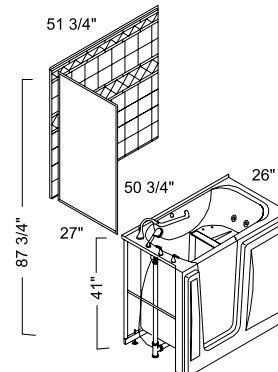

XTW5026 - With two walls

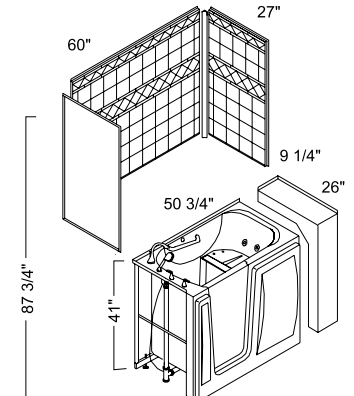

XTW5026 - With three walls and extension



escape plus

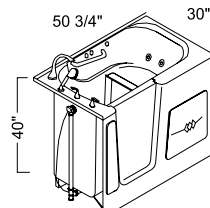

XTOW5030

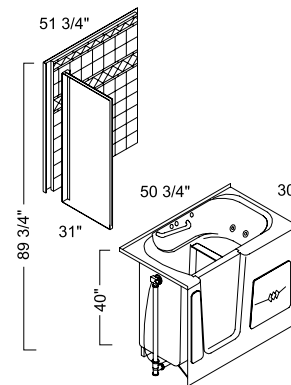

XTOW5030 - With two walls

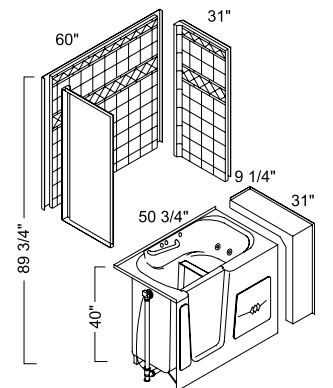

XTOW5030 - With three walls and extension

## Our Walk-in Tubs Feature:

- Durable and user friendly door latch. All stainless steel components, no plastic. Should any adjustment ever be required it is easily done at the lever. Patent pending.
- Jetted models feature the new Syllent Pump: the quietest whirlpool pump available. This is the only pump available with a heat recycling feature to help maintain water temperature and avoid the need for an in-line heater. This pump has no seals to leak, no bearings to wear out and has a 10 year manufacturer's warranty.
- Stainless steel cable operated tub drain mechanism with a lever handle for easy operation.
- Pre-installed plumbing with all connect lines for professional installation.
- Flip-up seat. This unique feature allows for easier entrance.
- Matching wall surround available.
- Optional ozone sanitation system available.



Life-time warranty on door seal



New Syllent Pump, no seals to leak



# BigE

Model: XTW6035

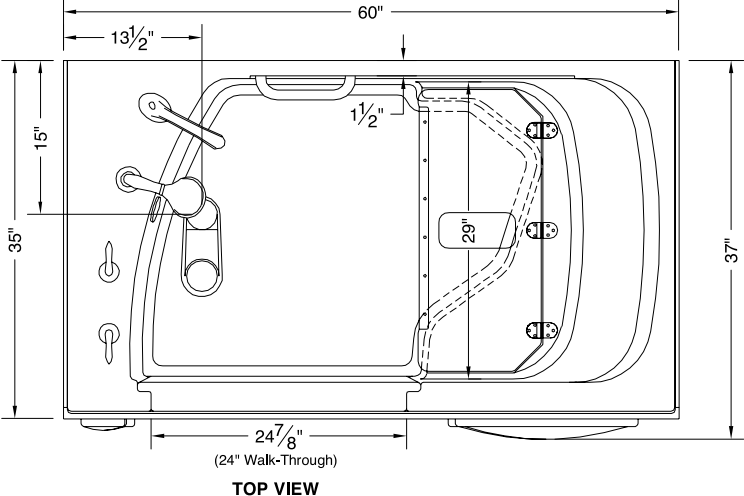

LIMITED  
*Lifetime*  
Walk-in Tub Warranty  
West Bath  
Made in America  
*Safe bathing for people of all abilities*

## BigE Features:

- Swing up seat for easy entry
- Seat height is designed for ease of sitting and standing
- Extra deep for a full body soak
- Largest door opening available
- Innovative new door handle designed for easy operation
- Allows you the freedom to rehab at home
- Installs in alcove, corner or along a wall
- Optional solid end panels for corner or open wall installation
- Optional extra drain for faster exit
- Optional Ozone sanitation system
- Limited lifetime warranty

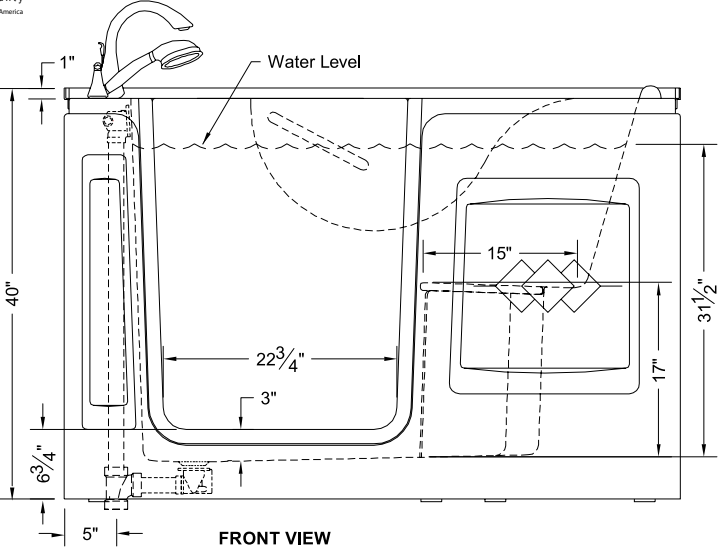

# barrier free and traditional curb models

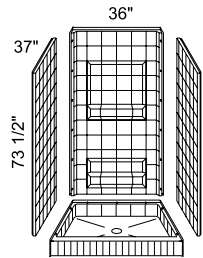

4RS3636

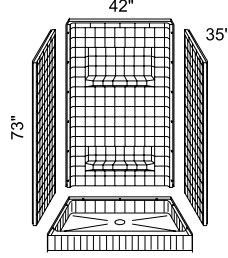

4RS4234

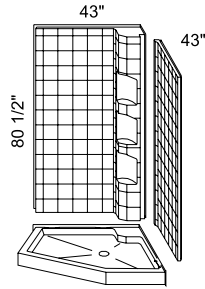

3LEN4242

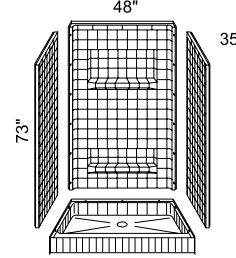

4RS4834

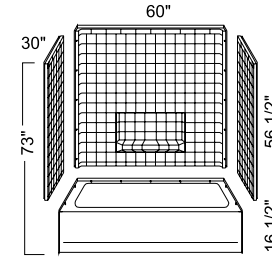

4RTS6029

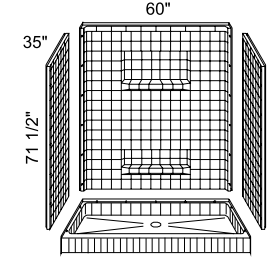

4RS6034

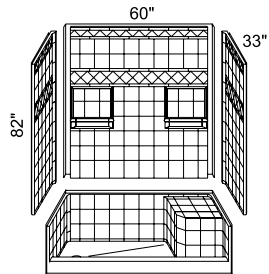

4LDS6032  
(also available in 60 x 30)

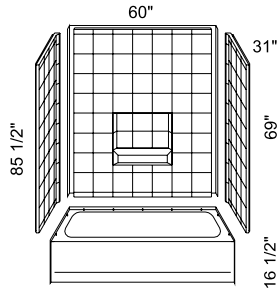

4LETS6030

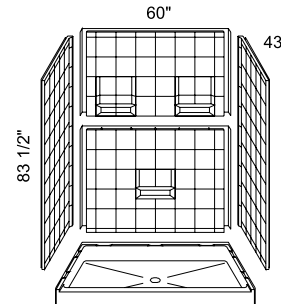

5LES6042

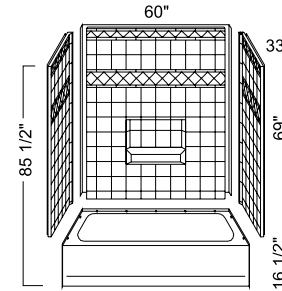

4LDS6032

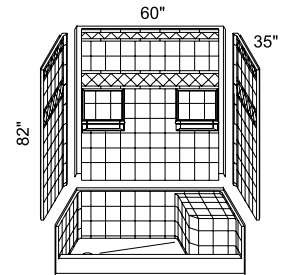

4LDS6034

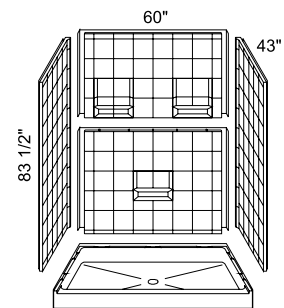

5LES6042

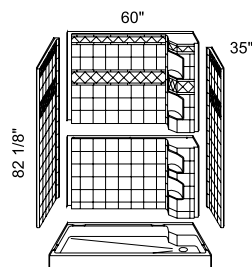

5LDS6034

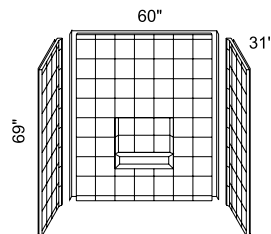

3EWS6030

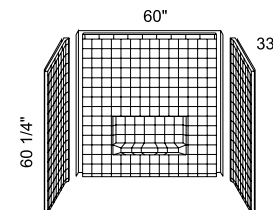

3RWS6032

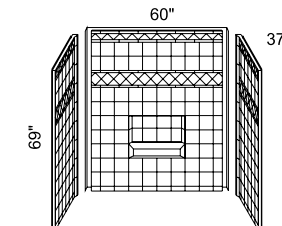

3DWS6036



Pans only are offered for all units. Many more models are available than what is shown.

# accessories

## seats

swing down legs with padded seat for comfort and extra stability



## waterstopper and curtain

the most effective low threshold water retention system available

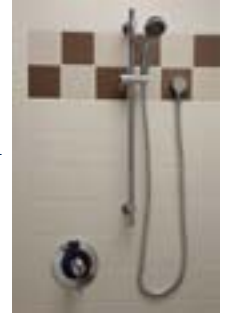

## shower heads and handhelds

glide bars to raise and lower handheld showers

## other accessories

- ramps
- weighted shower curtains
- semi-permanent thresholds



## soap dish

Light and strong

## stainless steel safety bars

choose from a variety of sizes and colors



*Safe Bathing for People of all Abilities Since 1971*



*Thanks to our buddies at Best Bath, the VERY BEST supplier we have - and we have some very good and well known suppliers. Best Bath is and will always be our best.*

Earl Weis, Access, Inc.

*I would like to tell you Best Bath has a great shower, and we can get any size we want. We have used 3 piece showers with a seat, 4 piece ADA Compliant showers, 1 piece ADA compliant showers and have never had a problem with any of them. They all have plywood backing so we can put seats, grab bars, hand held shower-heads, and valves wherever we need them. It is a very sturdy and reliable shower.*

*Finally, we have been working with other Housing Authorities across Nebraska as well as our own for at least 10 years and we have not found a more adaptable or better product anywhere. Believe me we have looked at and tried many others and this is by far the BEST BATH!*

*Thanks again, Randy Richter, Maintenance Supervisor  
The Housing Authority of the County of Scotts Bluff Nebraska*

## notes

---

---

---

---

---

---

---

---